

H8CF101

Assembly manual

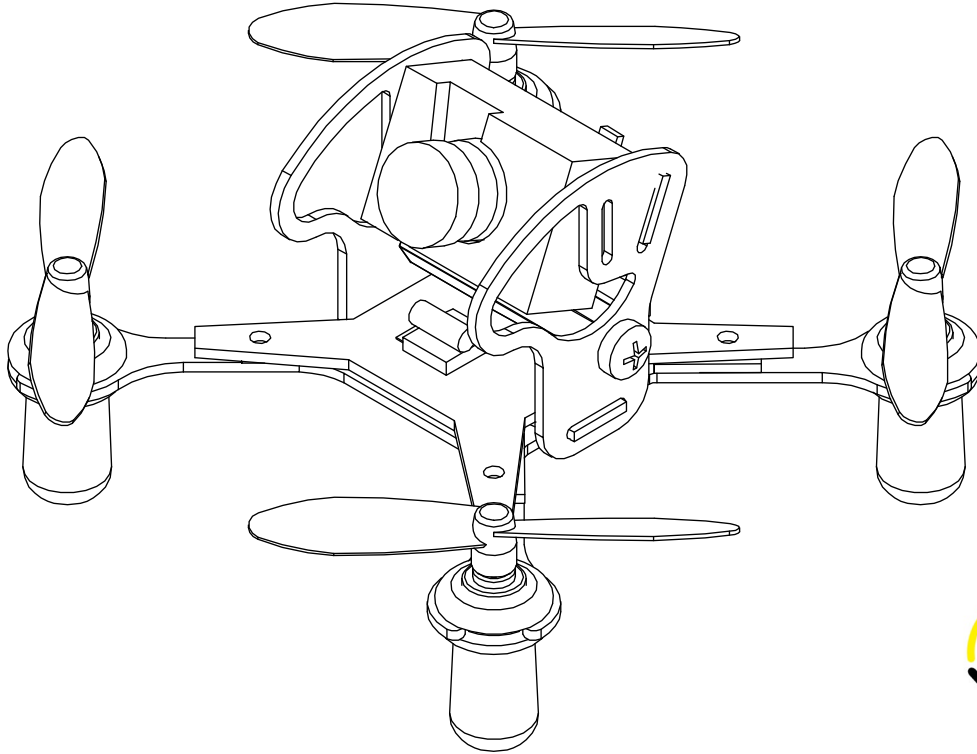

V1.20161004

Welcome and thank you for purchasing the H8CF101 conversion kit. I know you are looking forward to flying an advanced racing drone that can be customized and can deliver efficient air flow, a strong frame, and fantastic flying capabilities. In this manual you will find the instructions that will take you step by step to complete your drone and to start flying!

As you are working through the instructions it is important that you **READ THE DIRECTIONS!** There are fine points covered that you will miss if you only assemble by the pictures. You will enjoy your journey much more if you follow the instructions provided in this manual.

As always, we are dedicated to your drone flying experience and if you have thoughts, suggestions, concerns, or want to share a happy flight, please feel free to contact us!

outoftheboxinnovations@gmail.com

DISCLAIMER:

Out of the Box Innovations RC can not foresee the equipment you will purchase or how you will use the product when you receive it. We are not responsible for any injuries or property damage to anyone or anything as it relates to this product. **USE AT YOUR OWN RISK!**

Please go over this list below. Verify that all objects on this list are accounted for before building your quad-copter.

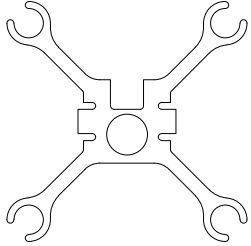



Main Plate
X 1

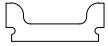

Side Plate
X 2



Camera Plate
X 1

	M3 x 6 nylon screw	x 2
	25mm Standoff	x 1
	Rubber Band	x 1
	Rubber Caps	x 4

You will need these items to fly your kit.

Eachine H8 or equivalent quad-copter.
8.5mm brushed motors x4
65mm propellers for the motors x4
(though extras are always recommended)

For FPV flight
Micro Camera with Built in VTX
FX798T Recommended

PICO male connector with small wire attached.

Battery Lipo 500mAh 25C rating or better.

Small philips head screwdriver

Soldering iron

Double Sided Sticky Tape

1

PCB PREPERATION

Remove the screws from under the H8 frame. Gently remove the top and de-solder the motors from the PCB. Gently remove the PCB from the quad-copter.

Solder your power tail from the male PICO connector to your PCB at the point where the battery connects to the PCB. Be sure to solder positive to positive and negative to negative. Reversing these may damage your FPV camera.

If you are going to flash your H8 to make it ACRO, then you'll also want to attach your flash leads at this time. Use as small a connector as possible to keep your weight to a minimum if you're going to leave it on the board.

3

BATTERY STRAP ASSEMBLY

Stretch the rubber band between the slots on the side of the main frame. The battery will be held in place between it and the frame underneath.

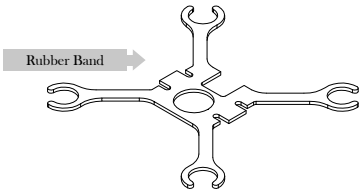

What you need for this step

Rubber Band x 1

2

SIDE PLATE ASSEMBLY

Attach the 25mm standoff to the side plate as shown with 1 nylon screw.

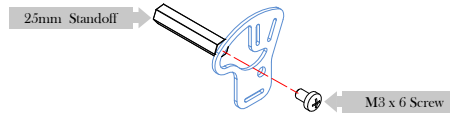

What you need for this step

M3 x 6 nylon x 1

screw x 1

25 MM Standoff

4

PCB ASSEMBLY

Cut small pieces of double sided tape to hold the PCB in place on the frame. Make sure the battery connector fits into the slot as shown. Be sure your PCB is relatively straight on the frame..

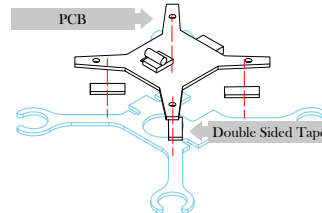

What you need for this step

PCB x 1

Double Sided

Stick Tape

5

PCB PREPERATION

Gently pinch the rubber grommet and insert into the groove at the end of each limb. Release the grommet and gently adjust any material until it rests in the groove. A little soapy water can make this part much easier.

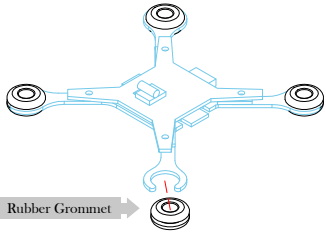

What you need for this step

Rubber Grommet	x 4
----------------	-----

7

POD ASSEMBLY

Assemble your side plates using the attached 25mm standoff and nylon screw. Be sure to secure the camera plate between the side plates. Be cautious of the rubber band and try not to pinch it with the side plates.

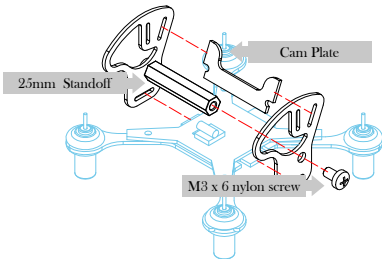

What you need for this step

Side Plates	x 1
25mm Standoff	x 1
M3 x 6 nylon screw	x 1
Camera Plate	x 1

6

MOTOR ASSEMBLY

Put a tiny bit of soapy water on the bottom of each grommet. Gently press the motors until they slide into place inside the grommet. Adjust the height until the top of the motor is about 5mm from the top of the frame.

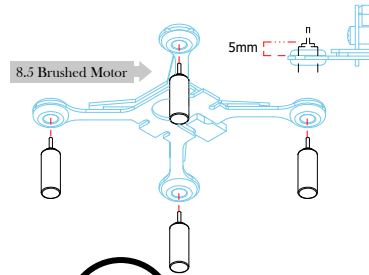

Re-connect your motors to the PCB and verify motor rotation. Be sure to leave a little slack in the wires for the protectors.

What you need for this step

8.5mm Motors	x 4
--------------	-----

8

FPV CAMERA ASSEMBLY

Mount your FPV camera using a small piece of double sided sticky tape and secure to the camera plate as shown. You can adjust from 0 degrees to 20 degrees angle on your camera by using the correct slots on the side plates.

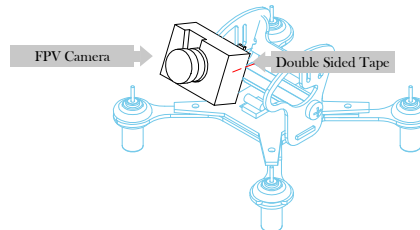

What you need for this step

FPV Camera	x 1
Double Sided Stick Tape	

9

PCB PREPERATION

Gently press on your new 65mm propellers onto the motors verifying the direction of the props.
Gently press on the rubber caps to the underside of the motors which will help protect the motors and wire connections.

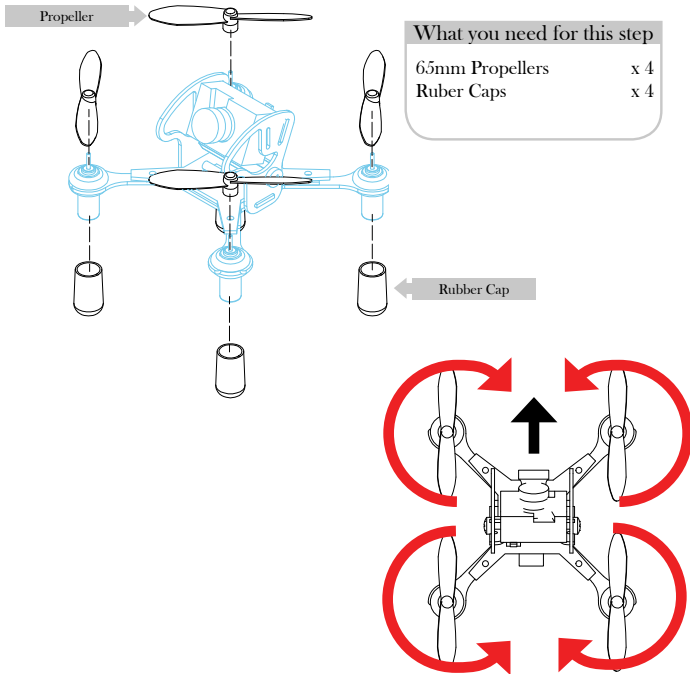

10

READY TO FLY

Now you've completed your build. Be sure to research your particular equipment and be sure it is 100% operational before attempting to fly.

WARNING: NEVER test your motors with the propellers on.

